

Energizer®

E2825C



TM

1. Your mobile

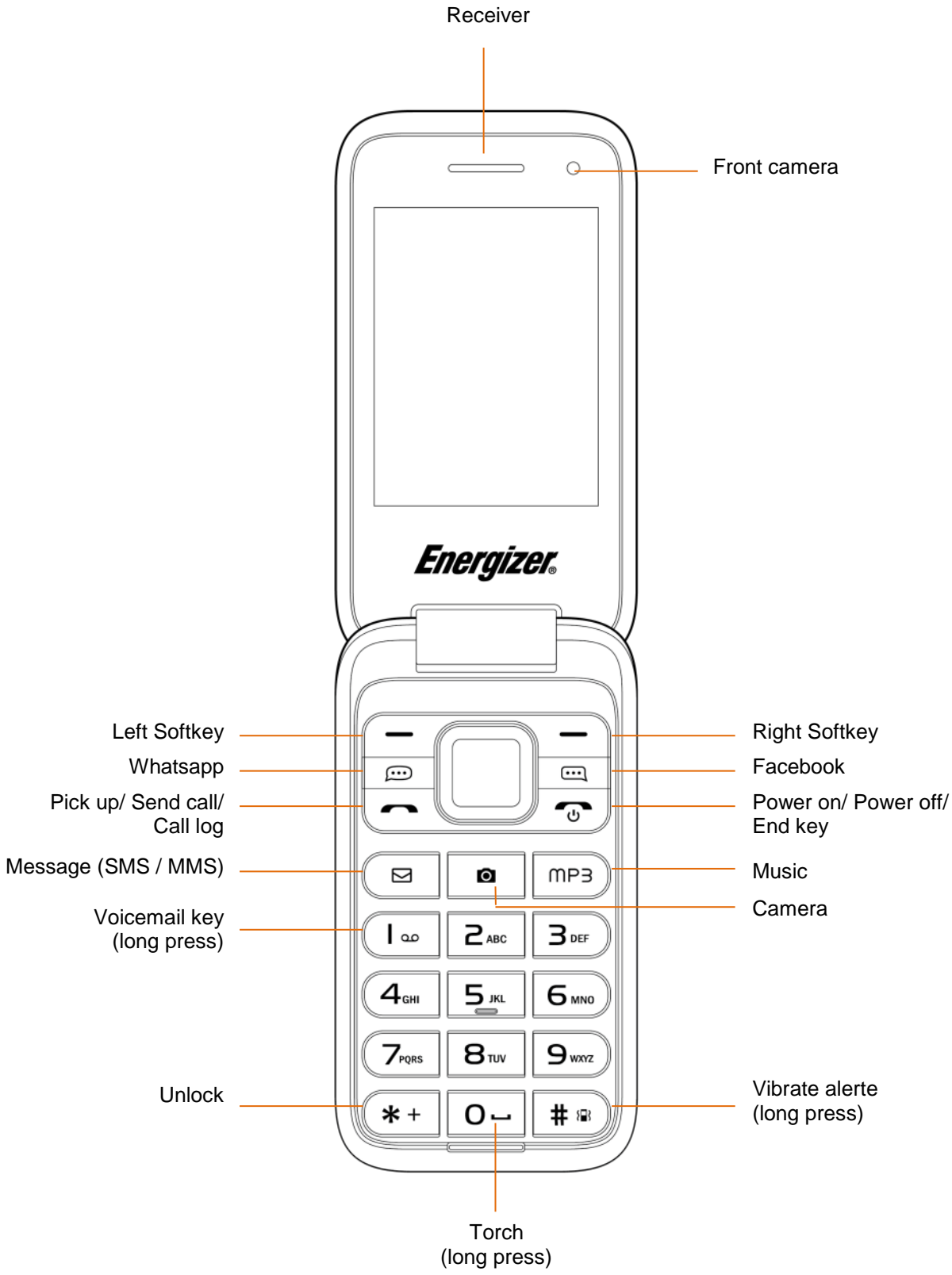

1.1 Keys



Navigation key

- Press to confirm an option
- Press: access app list (from the Home screen)
- Press to go left (Shortcut to Apps)/right (Settings) /up (Quick ShortCut, Menu)/down (KaiOS Card)



• **Left** - Access Notice



• **Right** - Access contacts



- Pick up/ Answer a call
- Press: Enter Call log



- Press: End a call / Return to the Home screen
- Long press: Power on/off, Menu



- Long press: Access your voicemail



From Idle screen

- Press: Enter 0
- Long press: "Turn On /Turn off the light

In Edit mode

- Press: Space
- Long press: 0



From Idle screen

- Press: *

In Edit mode

- Press: Access symbols table



From Idle screen

- Press: #
- Long press: Vibrate alert

In Edit mode: Change input methods



Quick access Whatsapp (left) / Facebook (right)



Quick access Message (left) / Music (right)

1.2 Status bar icons



Battery charge level.



Level of network reception.



Missed calls.



Flight mode.



4G LTE connection status.



3G / 2G connection status.



HSDPA / HSDPA+ connection status.



EDGE connection status.



WIFI connection status.



VoWiFi connection status



VoLTE connection status.



Music / Radio activated.



Headset connected / Headset Bluetooth connected.



Alarm set.



Notifications (SMS/MMS/MAIL/APPS).



Localization status.



USB connection status.



Bluetooth connection status.



Vibration mode.

1.3 Home screen

1.3.1 Widget bar

Widgets are convenient shortcuts for quick access from the Home screen.

Click on the left on the navigation key to access to the Widget bar

You can have quick access to Facebook / Maps / YouTube / Google / Whatsapp.

1.3.2 Change wallpaper

To adjust (or change) Wallpaper go to: Settings > Personalization > Display > Wallpaper

- Press Camera to take a picture for the Wallpaper you would like to use/Store .
- Press Wallpaper to select from pre-loaded Wallpapers.
- Press Gallery to select from Images that are stored on your device.

2. Getting started

2.1 Set up

Removing and installing the back cover

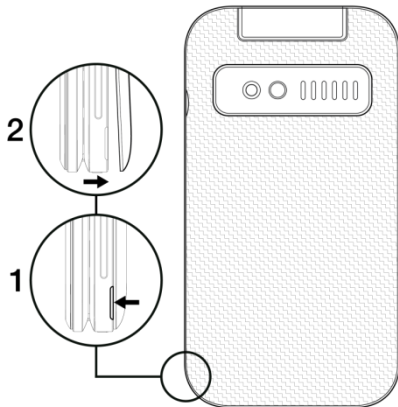

Removing and installing the battery

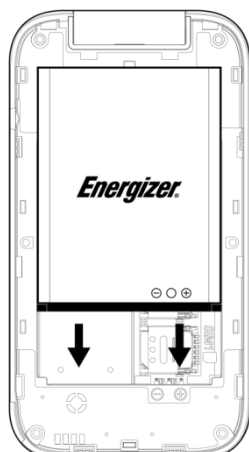

Inserting and removing the SIM card

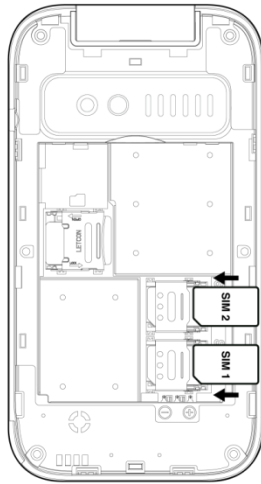

Place the SIM card with the chip facing downwards and slide it into its housing. Make sure that it is correctly inserted. To remove the card, press it and slide it out



For dual SIM model, SIM1 supports micro SIM and SIM 2 support micro SIM also. Do not attempt to insert other SIM types such as mini and Nano cards; otherwise this may cause damage to your phone.

Charging the battery

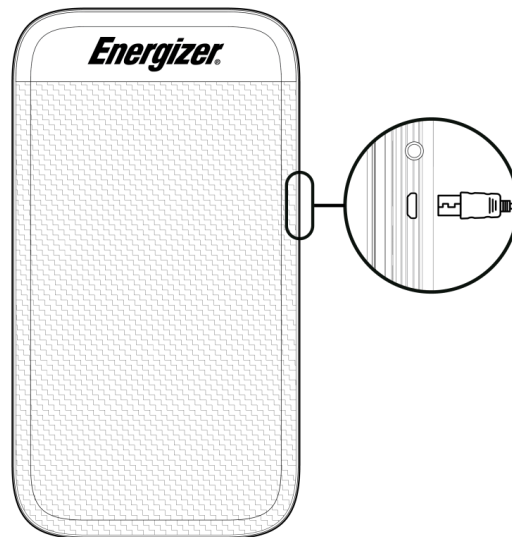

Connect battery charger to your phone and plug into the socket.



- Charging may take about 20 minutes to start if the battery is out of power.
- Be careful not to force the plug into the socket.
- Make sure the battery is correctly inserted before connecting the charger.
- The main socket must be near the phone and easily accessible (avoid electric extension cables).

- You are advised to charge the battery to its maximum when using the phone for the first time (approximately 3 hours).
- To reduce power consumption and energy waste, when battery is fully charged, disconnect your charger from the plug; reduce the backlight time, etc.



The charge is complete when the animation stops.

2.2 Power On/Off your phone

- On : Hold down the key  until the phone powers on.
- Off: Hold down the key  from the Home screen and click on “**Power off**”.

3. Making a call

Dial the desired number then press the Call key  to place the call.

You can also select a contact from **Contacts** by pressing up or down on the **Navigation Key** to select the desired contact and press the Call Key. If you make a mistake, you can delete the incorrect digits by pressing the right soft key .

To hang up the call, press the key .



Making an emergency call

Dial emergency number and press the key  to make an emergency call. This works even without a SIM card and without typing the PIN code.

3.1 Calling your voicemail

Press and hold **1_{oo}** to call voicemail.

3.2 Receiving a call

When you receive an incoming call, press the key  to talk and then hang up by pressing the key .

3.3 Available functions during the call

During a call, you can access your contacts, call log, messages, etc. without hanging up the phone.

4. Messages



4.1 Create message

You can select “**Message**” from the main menu to create text/multimedia message. You can type a message and customize your message by adding pictures, recordings, videos, etc (only available while editing an MMS). While writing a message, select "Options" to access all of the messaging options.

When you use Dual SIM functions, you can type a message and select to send it to a recipient in either the SIM1 or SIM2 directory.

4.2 Create MMS

An SMS will be converted to MMS automatically when images, videos, audio, slides, or attachments are inserted.





An SMS message of more than a certain number of characters (the number of characters depends on your language) will be charged as several SMS. An MMS message containing photos or sounds may also be billed as more than one message. Specific letters (accent) will increase the size of the SMS; this may cause multiple SMS to be sent to your recipient.

5. Contacts



5.1 Consult your contacts

To access the **contacts** from the Home screen, press the key right  and select the icon from the menu or press on the  key on the home screen.

For dual SIM model, the complete contacts of both SIM1 and SIM2 are available in this menu.

5.2 Adding a contact

Key Once accessing Contact app : You can add a new contact to your phone or SIM card by pressing the  left key and chose phone or SIM 1 or 2

6. Call log





6.1 Access

You can access the function using the following options:

- Select  from main menu
- Press the send key from main screen
- For dual SIM model, the contacts of both SIM1 and SIM2 are available in this menu

6.2 Answering/Declining a Call

When you receive a call:

- Press the Left Key  (Call Key) to answer;
- Press the Right Key  (the End/Power Key) to decline.

To mute the ringtone volume of an incoming call, press the Volume Key.

7. Games



You can have access to a multiples kind of games on the KAIOS store, section "Games"

8. Camera



Your mobile phone is fitted with a camera for taking photos and shooting videos:





- Store them in your "My files".
- Send them in a multimedia message (MMS) to a mobile phone.
- Customize your Home screen.
- Transfer them by data cable or memory card to your computer.

9. Media applications



9.1 Music

Access this feature from the main menu by selecting "**Music**". You will have full flexibility of managing music both on your phone and memory card.

Use this function to play audio files. Press  to play/pause the audio player, short press  or  for previous or next audio, in audio player interface, press  up or down to tune volume.

9.2 Image



Your images are stored in the "Image" library on your phone or SD card. Here, you can multi-mark, set as Wallpaper, set as contact icon, or send by MMS.

9.3 Videos



Use this function to play video files. Press  to play/pause the video, short press  up or down to tune volume.

9.4 FM radio



Your phone is equipped with a radio with RDS functionality. You can use the application as a traditional radio with saved channels or with parallel visual information related to the radio program on the display if you tune to stations that offer Visual Radio service. You can listen to it while running other applications. To use this feature you must plug in your headset. The headset functions as an antenna when connected to your phone.

10. Recorder



Accessing **Recorder** allows you to make voice or sound recordings. The phone supports AMR and WAV format files. The recording file you stopped will be stored in Record file list automatically.

11. My files



You will have access to all audio and visual files stored in Phone or Memory Card in **My files**. You can access a number of items in **Phone** or **Memory Card** with this option: **Alarm, Audio, Photos, Others, Video**, etc.

Inserting and removing the memory card:

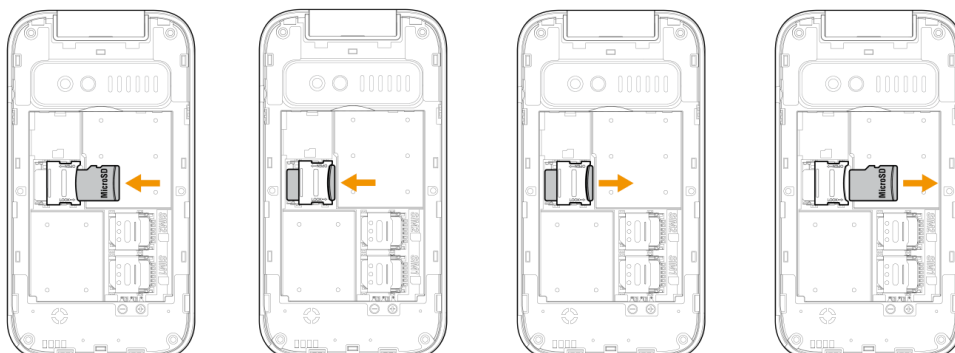

Place the microSD card with the chip facing downwards and slide it into its housing. Make sure that it is correctly inserted. To remove the card, press and slide it out.

12. Alarm



Your mobile phone has a built-in alarm clock with snooze feature.

13. Calculator



Press the up, down, left, right on the navigation key to select +, -, × and ÷ respectively. Press the Right soft key to delete the selection.

14. Calendar



Once you enter this menu from the main menu, there is a monthly-view calendar for you to keep track of important meetings, appointments, etc.

Days with events entered will be marked.

15. Notes



You can create a note in text format by accessing "Notes" from the main menu.

16. Converter



When weight is selected, you can quickly check the difference between kg-pound, and kg-ounce values. When length is selected, you can convert between km-mile, m-yard, m-foot and cm-inch values.

17. Internet



Using Browser, you can enjoy surfing the Web.

To access this function, press the Centre Soft Key from the Home screen and select Browser.

18. Settings



From the main menu, select the menu icon  and select the function of your choice in order to customize your phone.

Network & connectivity

Airplane mode, Mobile network & Data, Wi-Fi, Bluetooth, Geolocation, Calling Settings, Internet Sharing, Wireless Emergency Alerts.

Personalization

Sound, Display, Search, Notifications, Date & Time, Language, Input methods, Answer mode.

Privacy & Security

Screen Lock, SIM Security, App Permission, Do Not Track, Browsing Privacy.

Storage

Device

Device information, Downloads, Battery, Accessibility, Regulatory & Safety, Account, KaiOS Account, Anti-Theft

19. KaiStore



KaiStore allows you to download the applications you need.

Apps for smart feature phones: WhatsApp, YouTube, Facebook, Google Maps, and 500+ other apps available on the KaiStore.







Available items: Social, Games, Utilities, Lifestule, News, Shopping, Entertainment, Health, Sports, Books.

SECURITY INFORMATION

Please remember to obey relevant rules and regulations whenever use your phone. This will prevent bad effect from you and the environment.

General security

	Don't make or receive handheld calls while driving. And never text while driving.
	Don't use at petrol stations.
	Keep your phone at least 15 mm away from your ear or body while making calls.
	Your phone may produce a bright or flashing light.
	Small parts may cause a choking.
	Don't dispose of your phone in fire.
	Your phone can produce a loud sound.
	Avoid contact with anything magnetic.
	Keep away from pacemakers and other electronic medical devices.
	Avoid extreme temperatures.
	Switch off when asked to in hospitals and medical facilities.
	Avoid contact with liquids. Keep your phone dry.

	<p>Switch off when told to in aircrafts and airports.</p>
	<p>Don't take your phone apart.</p>
	<p>Switch off when near explosive materials or liquids.</p>
	<p>Only use approved accessories.</p>
	<p>Don't rely on your phone for emergency communications.</p>
	<p style="text-align: center;">Warning electrical hazard</p> <p style="text-align: center;">To avoid serious injury do not touch charger pins. Unplug the charger when not in use.</p> <p style="text-align: center;">To unplug a charger or an accessory, hold and pull the plug, not the cord.</p> <p style="text-align: center;">The power adaptor is the switch off device of the equipment. The wall power socket should be located near the equipment and easily accessible.</p>
<p style="text-align: center;">Look at the adapter regularly, specifically at the plug and the layer to detect any damages. If the adapter is damaged, you can't use it until it's fixed.</p> <p style="text-align: center;">Plug in the adapter to a power outlet which is easily accessible. Always unplug the adapter after using it.</p> <p style="text-align: center;">Use only the adapter provided with the device.</p>	

Do not expose your device to direct sunlight, like on your car's dashboard,
for example.

In case of overheating do not use the device.

Be careful when using the device while walking.

Do not subject the device to severe impact or drop it from high position,
it could cause damages or malfunctions.

Do not disassemble, modify or fix the device by yourself.

To clean the device uses a clean and soft rag.

Do not use any chemical product or detergent.

EU WEEE

Information to consumers in application of EU WEEE.



This product is subject to European Union regulations that promote the re-use and recycling of used electrical and electronic equipment. This product required the extraction and use of natural resources and may contain hazardous substances. The symbol above, on the product or its packaging, indicates that this product must not be disposed of with your other household waste. Instead, it is your responsibility to dispose of your waste equipment by handing it over to a designated collection point for the recycling of waste electrical and electronic equipment.

The separate collection and recycling of your waste equipment at the time of disposal will help to conserve natural resources and ensure that it is recycled in a manner that protects human health and the environment.

For more information about where you can drop of your waste equipment for recycling, please contact your local city office, your household waste disposal service, or the store from which you purchased the product.

Recommendations:

- Do not disassemble, open or tear up the device or the batteries.
- Do not expose the product or the battery to heat or fire. Avoid storage the device directly to the sunlight.
- Do not short-circuit a battery. Do not stock batteries in a drawer where it could short-circuit between each other or get in contact by any other metallic objects.
- Do not cause mechanical shocks to batteries.
- In case of the leak, do not let the liquid get in contact with your eyes or skin. If that happens wash with clear water the affected zone and seek medical advice.
- Follow the marks plus (+) and minus (-) on the battery and the device and ensure that the use is correct.
- Do not use any accessories or batteries that are not made to be used with the device.
- Monitor the use of a battery by children.
- Consult a doctor immediately in case of ingestion of an element or a battery.
- Always buy the battery recommended by the manufacturer of the device.
- Always maintain the product and the battery clean and dry.
- Wipe the terminals of the product or the battery, if it became dirty, with a clean and dry rag.
- It is necessary to charge the battery before its use. Always use the charger and read the manufacturer instructions or the manual of the device for the instructions regarding charging.
- Do not leave a battery charged when it's not going to be used.
- After long periods of storage, it may be necessary to charge and discharge the battery several times in order to achieve maximum performance.
- Always keep the original documentation of the device, you might need it later for future reference.
- If it's possible, take out the battery of the device when it's not used.
- Do not store your device in extremely hot or cold places like inside of a car during the summer. It might damage the device and cause explosion of the battery. It's recommended to use the device in a range of temperatures between 5°C and 35°C.

Prevention of the hearing loss

There are irreversible hearing loss risks if the receiver, the ear buds, the speaker or the headset are used at high volume. Regulate the volume to a level that does not present a danger. Over time, you can be used to a higher volume that will seem normal, but is harmful to your hearing. If you are experiencing buzzing or muffled

speech, we suggest that you consult a hearing specialist. Higher the volume, higher the risk that your hearing may be damaged quickly. Hearing specialists suggest the following recommendations:

- Limit the duration of use of high volume in headphones, the speaker or the handset.
- Avoid turning up the volume to cover a noisy environment.
- Turn the volume down if you cannot hear people speaking near you.

Please take time to read this important section.

RADIO WAVES

Proof of compliance with international standards (ICNIRP) or with European Directive 2014/53/EU (RED) is required of all mobile phone models before they can be put on the market. The protection of the health and safety for the user and any other person is an essential requirement of these standards or this directive.

THIS DEVICE MEETS INTERNATIONAL GUIDELINES FOR EXPOSURE TO RADIO WAVES

Your mobile device is a radio transmitter and receiver. It is designed not to exceed the limits for exposure to radio waves (radio frequency electromagnetic fields) recommended by international guidelines. The guidelines were developed by an independent scientific organization (ICNIRP) and include a substantial safety margin designed to assure the safety of all persons, regardless of age and health.

The radio wave exposure guidelines use a unit of measurement known as the Specific Absorption Rate, or SAR. The SAR limit for mobile devices is 2 W/kg.

Tests for SAR are conducted using standard operating positions with the device transmitting at its highest certified power level in all tested frequency bands.

Body-worn SAR testing has been carried out at a separation distance of 1.5 cm. To meet RF exposure guidelines during body-worn operation, the device should be positioned at least this distance away from the body. If you are not using an approved accessory, ensure that whatever product is used is free of any metal and that it positions the phone the indicated distance away from the body.

For more information you can go to www.energizeyourdevice.com

Additional information about electromagnetic fields and public health are available on the following site. <http://www.who.int/peh-emf>.

Your telephone is equipped with a built-in antenna. For optimal operation, you should avoid touching it or degrading it.

As mobile devices offer a range of functions, they can be used in positions other than against your ear. In such circumstances the device will be compliant with the guidelines when used with headset or USB data cable. If you are using another accessory ensure that whatever product is used is free of any metal and that it positions the phone at least 1.5 cm away from the body.

Please take time to read this important section.

RADIO WAVES

Proof of compliance with international standards (ICNIRP) or with European Directive 2014/53/EU (RED) is required of all mobile phone models before they can be put on the market. The protection of the health and safety for the user and any other person is an essential requirement of these standards or this directive.

THIS DEVICE MEETS INTERNATIONAL GUIDELINES FOR EXPOSURE TO RADIO WAVES

Your mobile device is a radio transmitter and receiver. It is designed not to exceed the limits for exposure to radio waves (radio frequency electromagnetic fields) recommended by international guidelines. The guidelines were developed by an independent scientific organization (ICNIRP) and include a substantial safety margin designed to assure the safety of all persons, regardless of age and health.

EU Regulatory Conformance

Hereby, this device is in compliance with the essential requirements and other relevant provisions of Directive 2014/53/EU.

For the declaration of conformity, visit the Web site www.energizeyourdevice.com

Notice: Observe the national local regulations in the location where the device is to be used. This device may be restricted for use in some or all member states of the European Union (EU)

Notes:

- Due to the used enclosure material, the mobile phone shall only be connected to a USB Interface of version 2.0 or higher. The connection to so called power USB is prohibited.
- The adapter shall be installed near the equipment and shall be easily accessible.
- Do not use the mobile phone in the environment at too high or too low temperature, never expose the mobile phone under strong sunshine or too wet environment. The suitable temperature for the phone and accessories is -10°C - 55°C .
- When charging, please place the phone in an environment that has a normal room temperature and good ventilation. It is recommended to charge the phone in an environment with a temperature that ranges from 5°C ~ 25°C . Please ensure to use only the charger offered by the manufacturer. Using unauthorized charger may cause danger and violate the authorization of the phone and the guarantee article.
- CAUTION: RISK OF EXPLOSION IF BATTERY IS REPLACED WITH AN INCORRECT TYPE. DISPOSE USED BATTERIES ACCORDING TO THE INSTRUCTIONS
- Excessive sound pressure from earphones and headphones can cause hearing loss.

For more information you can go to **www.energizeyourdevice.com**

Additional information about electromagnetic fields and public health are available on the following site. <http://www.who.int/peh-emf>.

Your telephone is equipped with a built-in antenna. For optimal operation, you should avoid touching it or degrading it.

As mobile devices offer a range of functions, they can be used in positions other than against your ear. In such circumstances the device will be compliant with the guidelines when used with headset or USB data cable. If you are using another accessory ensure that whatever product is used is free of any metal and that it positions the phone at least 1.5 cm away from the body.



**CERTIFICATE OF CONFORMITY
E282SC**

We, **AVENIR TELECOM**,
(208, Boulevard de Plombières, 13581 Marseille Cedex 20, FRANCE)
Hereby declares that:

ENERGIZER complies with the standards and provisions of the directives. The certificate of conformity procedure defined in article IV of directive 2014/53/EU has been under the control of the following organization:

BAY AREA COMPLIANCE LABORATORIES CORP.
1274 Anvilwood Ave. Sunnyvale, CA 94089. USA
www.baclcorp.com
Phone: +1 408 732 9162 Fax: +1 408 732 9164

The full text of the certificate of conformity of the device is available upon request by mail at the following address: **AVENIR TELECOM** - 208, Boulevard de Plombières, 13581 Marseille Cedex 20, France.

06/08/2021

(Date)

Jean-Daniel BEURNIER / CEO

(Name and signature of authorized person)

Maximum SAR for this model and conditions under which it was recorded:	
GSM 900	0.129 W/kg 10g Head SAR 1.509 W/kg 10g Body SAR
DCS 1800	0.106 W/kg 10g Head SAR 0.548 W/kg 10g Body SAR
WCDMA Band 1	0.229 W/kg 10g Head SAR 1.729 W/kg 10g Body SAR
WCDMA Band 8	0.064 W/kg 10g Head SAR 0.430 W/kg 10g Body SAR
LTE Band 1	0.122 W/kg 10g Head SAR 1.356 W/kg 10g Body SAR
LTE Band 3	0.178 W/kg 10g Head SAR 0.798 W/kg 10g Body SAR
LTE Band 7	0.118 W/kg 10g Head SAR 1.086 W/kg 10g Body SAR
LTE Band 8	0.092 W/kg 10g Head SAR 0.375 W/kg 10g Body SAR
LTE Band 20	0.412 W/kg 10g Head SAR 0.659 W/kg 10g Body SAR
LTE Band 28	0.170 W/kg 10g Head SAR 0.826 W/kg 10g Body SAR

LTE Band 38	0.063 W/kg 10g Head SAR 0.618 W/kg 10g Body SAR
LTE Band 40	0.123 W/kg 10g Head SAR 1.001 W/kg 10g Body SAR
WLAN 2.4GHz	0.367 W/kg 10g Head SAR 0.092 W/kg 10g Body SAR

During use, the actual SAR values for this device are usually well below the values stated above. This is because, for purposes of system efficiency and to minimize interference on the network, the operating power of your mobile device is automatically decreased when full power is not needed for the call. The lower the power output of the device, the lower its SAR val